

Lemi[®]
ITALIAN WELLNESS EQUIPMENT



FAVORITE
TREATMENT TABLE MANUFACTURER

All EVO spa tables feature a mattress with HBS Stress Relief System. This is the innovative system by which the head, the back and the shoulders can be stimulated without stretching and contractures, thanks to the possibility of lowering the armrests and adjusting the headrest.

Tutti i lettini EVO presentano il materasso con Sistema Anti Stress HBS, si tratta dell'innovativo sistema col quale testa, schiena e braccia possono essere stimolate senza stiramenti e contratture, grazie alla possibilità di abbassare i braccioli e regolare l'appoggiatesta.

EVO

EVO

GEMINI EVO

GEMINI EVO

NEW

AVAILABLE CONFIGURATIONS
CONFIGURAZIONI DISPONIBILIWENGÉ
WHITE
BIANCO
TAUPE
TORTORA

*KIT WENGÉ - KIT WHITE - KIT TAUPE



Covered columns / Colonne rivestite



COD. 1369

Multi-functional treatment table that combines comfort and ease of use. Thanks to the innovative mattress with HBS Stress Relief System, guarantees maximum comfort for both the client and practitioner alike. Equipped with three independent height, backrest and legrest adjustments and a solid painted wooden base with double column elegantly covered. Available in 3 standard color configurations.

IDEAL FOR: massages, face and body treatments, hair removal, treatments with aesthetic equipment.

Lettino SPA multifunzionale che combina praticità di utilizzo e comfort. Grazie all'innovativo materasso con Sistema Anti Stress HBS, garantisce il massimo comfort cliente / operatore. Dotato di tre regolazioni autonome di altezza, schienale e poggiatesta ed una solida base in legno verniciato con doppia colonna elegantemente rivestita. Disponibile in 3 configurazioni colori standard.

IDEALE PER: massaggi, trattamenti viso e corpo, depilazione, trattamenti con apparecchiature estetiche.

* The images are for illustrative purposes only and may not reflect the actual image of the finishing.

* Le immagini hanno valore puramente illustrativo e possono non rispecchiare l'immagine reale della finitura.

Focus on

- 3 electric motors for height, backrest and legrest adjustment
- Standard handset control with 2 options for MEMORY function
- AUT function: automatic return from any position to zero position (flat and minimum height)
- END function: "End of treatment" position
- SYNCRO function: synchronized backrest/legrest adjustment
- Painted wood base with double column covered
- Available in 3 standard color configurations (mattress + base)
- The HBS Stress Relief System provides perfect ergonomics for the client's head, back and shoulders
- Fire resistant "Azo" free, anti-bacterial and anti-fungal covering
- Multifunctional solution, maximum customer / operator comfort

- 3 motori elettrici per regolazione di altezza, schienale e poggiatesta
- Pulsantiera standard con 2 opzioni di funzione MEMORIE
- Funzione AUT: ritorno automatico da ogni posizione alla posizione zero (piatto e altezza minima)
- Funzione END: posizione "fine del trattamento"
- Funzione SYNCRO: regolazione schiena/gambe sincronizzata
- Base in legno verniciato e doppia colonna rivestita
- Disponibile in 3 configurazioni colori standard (materasso + base)
- Il Sistema Anti Stress HBS garantisce perfetta ergonomia per testa, spalle e schiena
- Rivestimento ignifugo, "Azo" free, antibatterico, antimicotico
- Soluzione multifunzionale, massimo comfort cliente / operatore

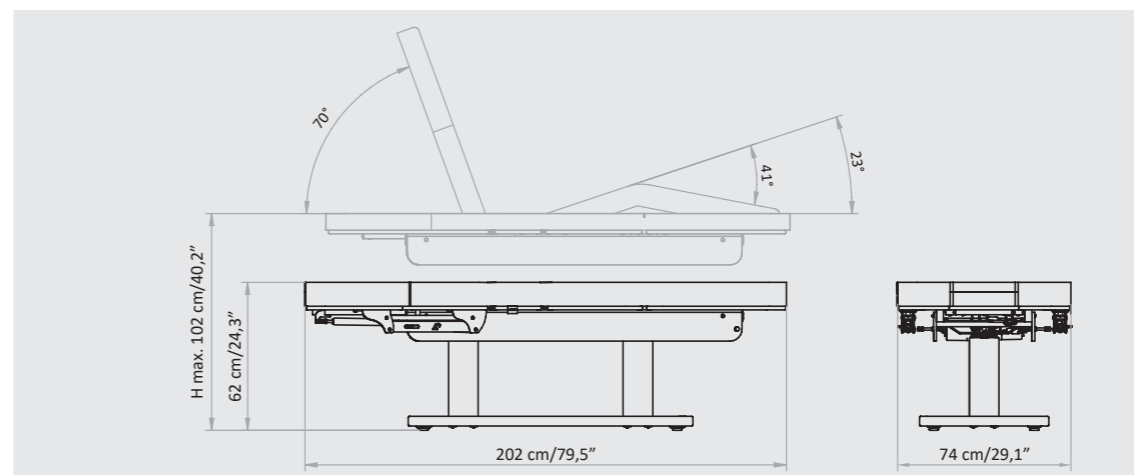

Packaging details

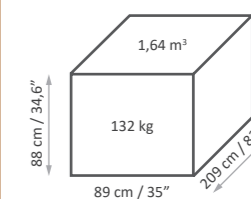

MAXIMUM CAPACITY
PORTATA MASSIMA
200 kg

MATTRESS CUSTOMIZATION PERSONALIZZAZIONE MATERASSO

3 STANDARD CONFIGURATION OPTIONS* / 3 OPZIONI DI CONFIGURAZIONE STANDARD*



*Any modification to the mattress finishes **EXCLUDES** the **COLUMNS**. / L' eventuale modifica delle finiture del materasso **ESCLUDE** le **COLONNE**.

MATTRESS WIDTH LARGHEZZA MATERASSO

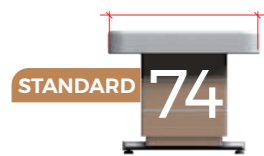

STANDARD 74

S - 74 CM / 29,1"

Standard Width - 74 cm / 29,1"
Larghezza Standard - 74 cm / 29,1"



82

M - 82 CM / 32,3"

Medium Width - 82 cm / 32,3"
Larghezza Medium - 82 cm / 32,3"



90

L - 90 CM / 35,4"

Large Width - 90 cm / 35,4"
Larghezza Large - 90 cm / 35,4"

MATTRESS THICKNESS SPESSORE MATERASSO



9

COMFORT - 9 CM / 3,5"

Mattress with high density foam for energetic massages

Materasso con gomma ad alta densità per massaggi energici



STANDARD 12

EXTRA COMFORT - 12 CM / 4,7"

Comfortable mattress for relax massages

Materasso confortevole per massaggi relax



15

SUPER SOFT - 15 CM / 6" with Memory Foam

Super soft mattress with memory foam, available ONLY for 74 cm / 29,1" and 82 cm / 32,3" width

Materasso super soft con memory foam, disponibile SOLO per larghezze 74 cm e 82 cm

ACCESSORIES UPON REQUEST ACCESSORI SU RICHIESTA

All tables have a standard setting customizable upon request.

Tutti i lettini hanno una configurazione standard personalizzabile su richiesta.



Oil-resistant protection
Proteggi materasso resistente agli oli



Luxury "Dreamsoft" cover
Coprilettino Dreamsoft



Luxury towel
Telo Deluxe



Roll Holder (75 cm)
Portarotolo (75 cm)



Adjustable cushion
Cuscino regolabile



Disposable EVO Headrest cover (pack 100 pcs.)
Copritesta EVO monouso (confezione 100 pz.)

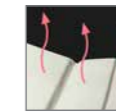

Heating system
Riscaldamento



UK cable
Cavo UK



USA cable
Cavo USA

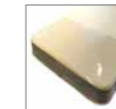

Plastic leg protection
Protezione gambe in plastica



Customized mattress with logo
Personalizzazione materasso con logo

The images are for illustrative purposes only and may not reflect the actual finish of the product, particularly when viewed through a screen. Therefore, the **SELECTION OF THE FINISHES** of the **BASES** and **MATTRESS FABRICS** must take place **AFTER CONSULTING** the **LUXURY BOX PHYSICAL SAMPLES** and the **COLOR CHARTS**.

Le immagini hanno valore puramente illustrativo e possono non rispecchiare la finitura reale del prodotto, in particolare se visualizzate attraverso uno schermo. Pertanto la **SELEZIONE DELLE FINITURE** delle **BASI** e dei **RIVESTIMENTI** dei **MATERASSI** deve avvenire **PREVIA CONSULTAZIONE** della **CAMPIONATURA FISICA** della **LUXURY BOX** e delle **CARTELLE COLORI**.

LEMI MATTRESSES STANDARD

Each mattress is HANDCRAFTED, therefore the ACTUAL MEASUREMENTS MAY VARY from those indicated in the catalogue by approximately ± 1 cm (also based on the selected configuration).



EVO LINE - STANDARD

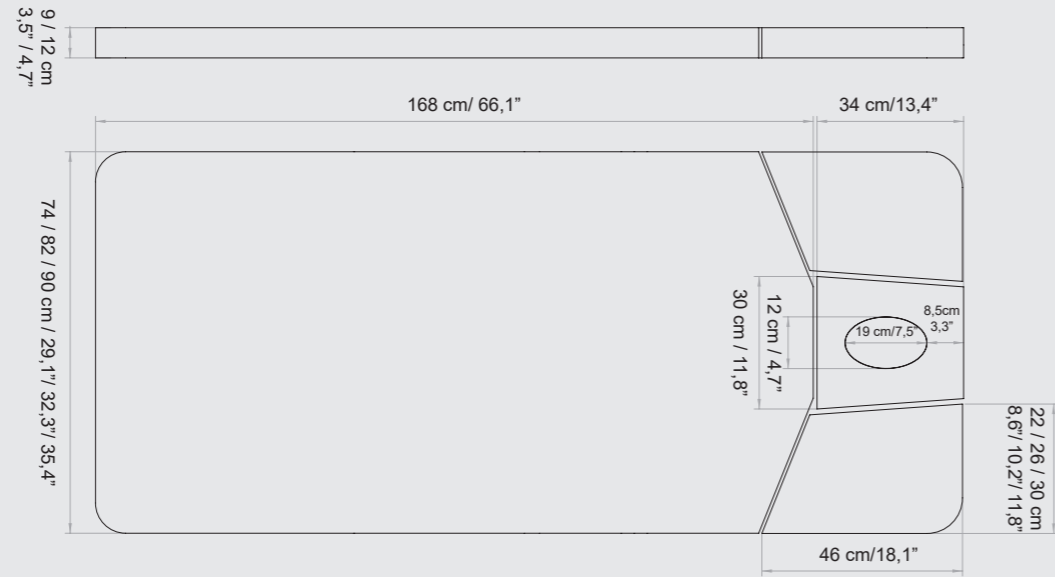

AVAILABLE FOR WIDTH / DISPONIBILE PER LARGHEZZA: 74 / 82 / 90 CM

MATERASSI LEMI MEMORY

Ogni materasso è realizzato A MANO, pertanto le MISURE REALI POTREBBERO VARIARE rispetto a quelle indicate nel catalogo di circa ± 1 cm (anche in base alla configurazione selezionata).

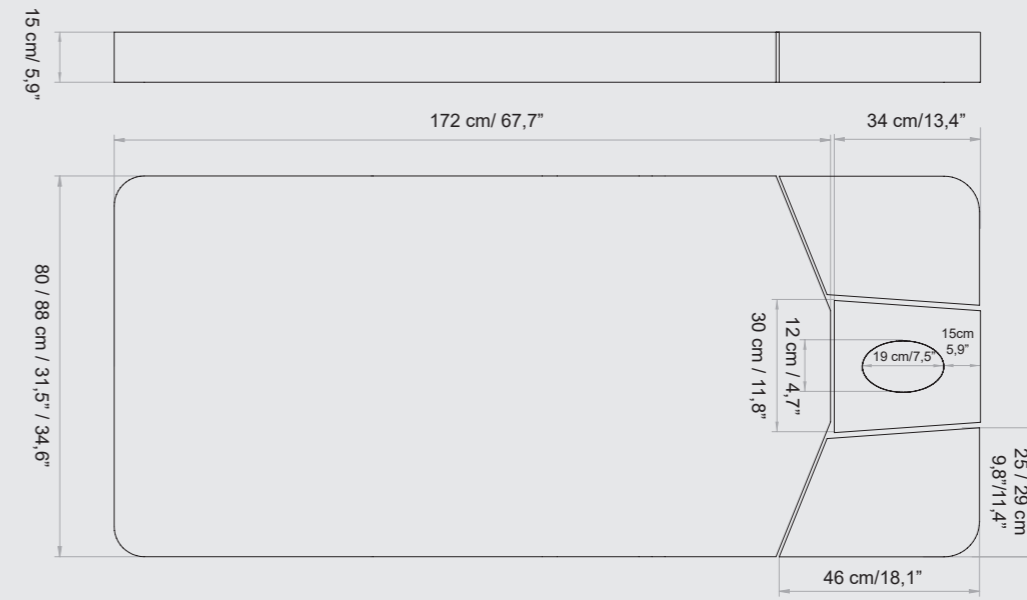

AVAILABLE FOR WIDTH / DISPONIBILE PER LARGHEZZA: 74 / 82 CM



EVO LINE - MEMORY

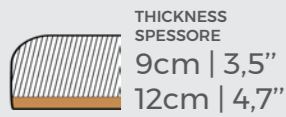

VERONA EVO - STANDARD

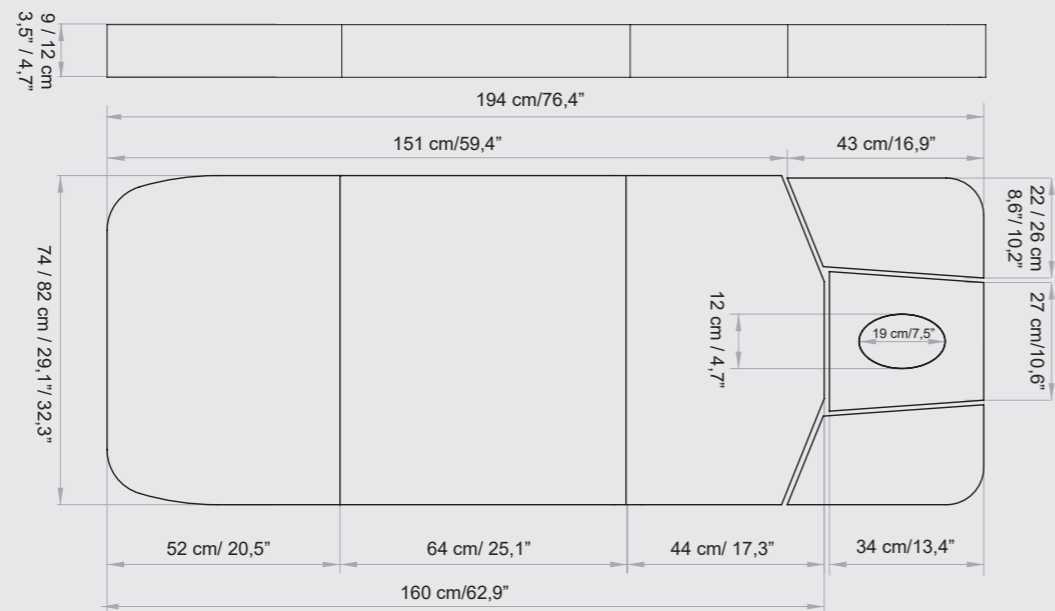

AVAILABLE FOR WIDTH / DISPONIBILE PER LARGHEZZA: 74 / 82 CM

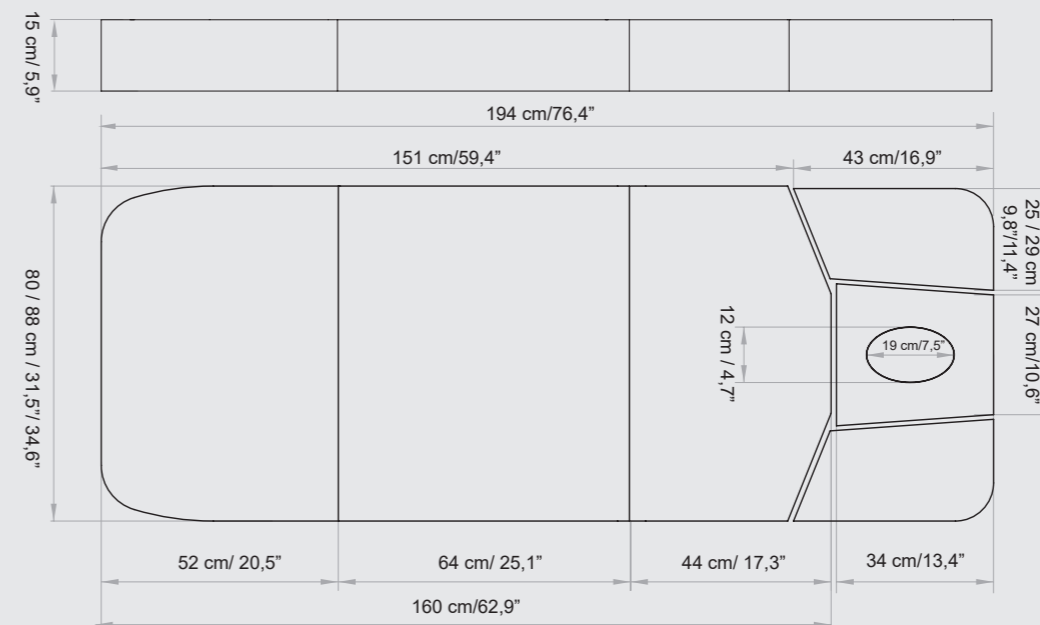

AVAILABLE FOR WIDTH / DISPONIBILE PER LARGHEZZA: 74 / 82 CM



VERONA EVO - MEMORY

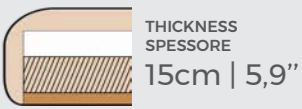
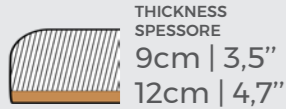

TECHNICAL REQUIREMENTS

CARATTERISTICHE TECNICHE

ABSORPTION ASSORBIMENTO	VOLTAGE VOLTAGGIO	POWER POTENZA	FREQUENCY FREQUENZA	WARRANTY	GARANZIA
4 Amax (1,7 A)	100 Vac (240Vac)	250W	50/60 Hz	<i>Mattress heating: 1 year</i> <i>Electric parts and controls: 3 years</i> <i>Undeformable foam: 5 years</i> <i>Actuators: 5 years</i> <i>Structure: Lifetime</i>	Riscaldamento materasso: 1 anno Parti elettriche e comandi: 3 anni Gomma indeformabile: 5 anni Attuatori: 5 anni Struttura: a vita

REGULATIONS

All Equipment is **CE** marked

Electrical equipment and beds

Directive 2006/42/CE (Machinery Directive) and national regulations

Directive 2014/30/UE (Electromagnetic Compatibility Directive) and national regulations.

Images

The images are for illustrative purposes only and may not reflect the actual image of the product.

NORME

Tutte le attrezzature sono a marchio **CE**

Attrezzature e lettini elettrici

Direttiva 2006/42/CE (Direttiva Macchine) e disposizioni nazionali di attuazione

Direttiva 2014/30/UE (Direttiva Compatibilità elettromagnetica) e disposizioni nazionali di attuazione.

Immagini

Le immagini hanno valore puramente illustrativo e possono non rispecchiare l'immagine reale del prodotto.

Lemi[®]
ITALIAN WELLNESS EQUIPMENT

Brusaferrì & C srl

Via Mara Maretti Soldi, 13
26011 Casalbuttano (CREMONA) ITALY
Phone +39-0374-363069 Fax +39-0374-363071
info@lemigroup.it service@lemigroup.it

www.lemigroup.it