

Lemi[®]
ITALIAN WELLNESS EQUIPMENT



BEAUTY

The BEAUTY line includes a whole series of multifunctional chairs that can be adjusted in any position, until they become a completely horizontal bed. All the chairs are suitable for face treatments, body treatments, hair removal, pressure therapy, manicures and pedicures.

La linea BEAUTY include una serie completa di poltrone multifunzionali che possono essere regolate in ogni posizione, fino a divenire un lettino completamente orizzontale. Tutte le poltrone sono adatte per trattamenti viso, trattamenti corpo, epilazione, pressoterapia, manicure e pedicure.



* B: Bianco | M: Nefos 6986

Version with anatomic mattress and flat armrests
Versione con materasso anatomico e braccioli automatici

Extendable footrest / Piede allungabile

COD. 1158

Lemi Syncro Bi-Zak is equipped with high-performance and silent electronics and a practical standard foot pedal control. Synchronized backrest/legrest movement. Bi-Zak mattress with wide customization.

IDEAL FOR: massages, face and body treatments, hair removal, treatments with aesthetic equipment.

Lemi Syncro Bi-Zak è dotata di elettronica altamente performante e silenziosa e di una pratica pedaliera standard. Movimento sincronizzato schiena/gambe. Materasso Bi-Zak con ampia possibilità di personalizzazione.

IDEALE PER: massaggi, trattamenti viso e corpo, depilazione, trattamenti con apparecchiature estetiche.

** The images are for illustrative purposes only and may not reflect the actual image of the finishing.*

** Le immagini hanno valore puramente illustrativo e possono non rispecchiare l'immagine reale della finitura.*

Focus on

- Standard foot pedal control with 2 MEMORY functions
- END function: automatic return to flat position (flat and minimum height)
- AUT function: automatic return to the original position (chair)
- Fire resistant, "Azo" free, antibacterial and antifungal mattress covering
- Entirely enclosed ABS casing
- Fully customizable
- Standard version includes: 3 electric motors for height, backrest-legrest (synchronized) and tilting adjustment, foot pedal control and flat Bi-Zak mattress (adjustable headrest and footrest)
- Pedaliera standard con 2 funzioni MEMORIE
- Funzione END: ritorno automatico alla posizione piatta (piatto e altezza minima)
- Funzione AUT: ritorno automatico alla posizione base (poltrona)
- Rivestimento ignifugo, "Azo" free, antibatterico, antimicotico
- Carter in ABS completamente chiuso
- Totalmente personalizzabile
- La versione standard include: 3 motori elettrici per regolazione altezza, schienale-gamba (sincronizzate) e basculante, pedaliera e materasso piatto Bi-Zak (testa e piedi regolabili)

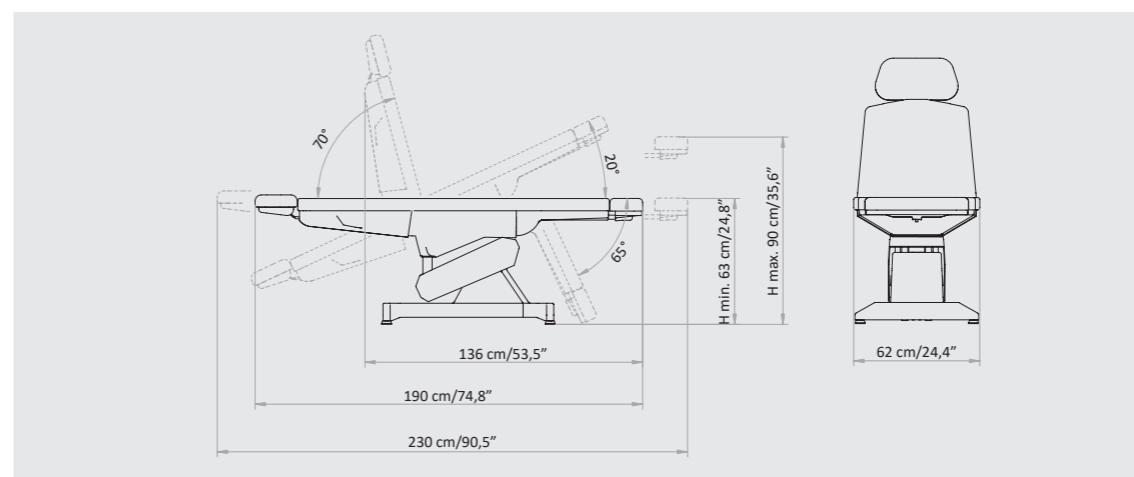
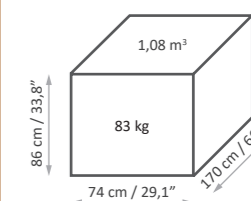
**Packaging details**

MAXIMUM CAPACITY
PORTATA MASSIMA
200 kg

MATTRESS CUSTOMIZATION PERSONALIZZAZIONE MATERASSO

VITA - COLOR CHART



EV00021



EV00022



EV00041



EV00042

SPA PRESTIGE - COLOR CHART



9916



1424

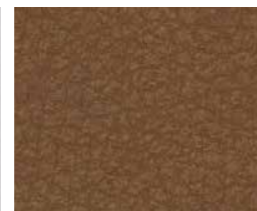

1423



1422

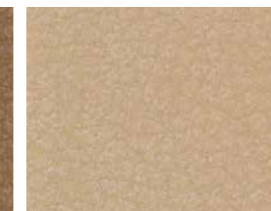

2202



2204



7022



7023



1875



1530

NEFOS - COLOR CHART



6



1957



6985



3962



1155



2124



1194



2173



6986



569



667



680



64



71

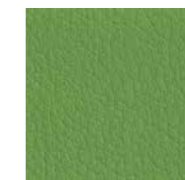

1868

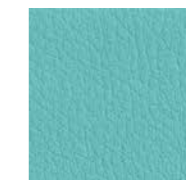

1843



8019



8009



5946



6940



6941



6942



1388

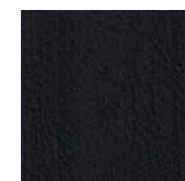

991

The innovative VITA (consisting of 80% natural and renewable components), Spa Prestige and Nefos materials - which are exclusive for LEMI products - and their special finishing touch guarantee easy-cleaning and hygiene. Their extraordinary structural qualities will persist through the years. An incredibly elastic texture enhances the memory foam mattress softness and quality at its best, giving Spa Clients a complete and satisfying wellness experience.

Gli innovativi materiali VITA (costituiti per l'80% da componenti naturali e rinnovabili), Spa Prestige e Nefos - che sono un'esclusiva dei prodotti LEMI - ed il loro speciale tocco di finitura garantiscono una facile pulizia e igiene. Le loro straordinarie qualità strutturali permangono nel corso degli anni. Una texture incredibilmente elastica migliora al massimo la morbidezza e la qualità del materasso in Memory Foam, dando ai clienti Spa un'esperienza di benessere completa e soddisfacente.

The images are for illustrative purposes only and may not reflect the actual finish of the product, particularly when viewed through a screen. Therefore, the **SELECTION OF THE FINISHES** of the **BASES** and **MATTRESS FABRICS** must take place **AFTER CONSULTING** the **LUXURY BOX PHYSICAL SAMPLES** and the **COLOR CHARTS**.

Le immagini hanno valore puramente illustrativo e possono non rispecchiare la finitura reale del prodotto, in particolare se visualizzate attraverso uno schermo. Pertanto la **SELEZIONE DELLE FINITURE** delle **BASI** e dei **RIVESTIMENTI** dei **MATERASSI** deve avvenire **PREVIA CONSULTAZIONE** della **CAMPIONATURA FISICA** della **LUXURY BOX** e delle **CARTELLE COLORI**.

BASE CUSTOMIZATION PERSONALIZZAZIONE BASE



We provide a thermoformed ABS base, completely closed to prevent any infiltration of powders or liquids. The result is a very strong material that is scratch resistant and easy to clean.

Forniamo una base in ABS termoformato, completamente chiuso per evitare qualsiasi infiltrazione di polveri o liquidi. Il risultato è un materiale molto robusto, resistente ai graffi e facile da pulire.











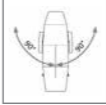





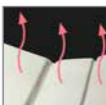

The images are for illustrative purposes only and may not reflect the actual finish of the product, particularly when viewed through a screen. Therefore, the **SELECTION OF THE FINISHES** of the **BASES** and **MATTRESS FABRICS** must take place **AFTER CONSULTING** the **LUXURY BOX PHYSICAL SAMPLES** and the **COLOR CHARTS**.

Le immagini hanno valore puramente illustrativo e possono non rispecchiare la finitura reale del prodotto, in particolare se visualizzate attraverso uno schermo. Pertanto la **SELEZIONE DELLE FINITURE** delle **BASI** e dei **RIVESTIMENTI** dei **MATERASSI** deve avvenire **PREVIA CONSULTAZIONE** della **CAMPIONATURA FISICA** della **LUXURY BOX** e delle **CARTELLE COLORI**.

ACCESSORIES UPON REQUEST ACCESSORI SU RICHIESTA

All tables have a standard setting customizable upon request.

Tutti i lettini hanno una configurazione standard personalizzabile su richiesta.

- | | | | |
|---|---|---|--|
|  | <i>Manicure bowls with frame support</i>
Coppia bacinelle manicure |  | <i>Seat with 180° rotation</i>
Opzione rotazione 180° |
|  | <i>Abs plastic tray with metal support</i>
Vaschetta in plastica abs con supporto in metallo |  | <i>Small Zak headrest</i>
Testa Zak piccola |
|  | <i>Abs plastic tray with metal support</i>
Vaschetta in plastica abs con supporto in metallo |  | <i>Strip headrest with face hole</i>
Testa strip con foro viso |
|  | <i>Zak cover with polyurethane</i>
Coprilettino materasso Zak con poliuretano |  | <i>Heating system</i>
Riscaldamento |
|  | <i>Anatomic Bi-Zak mattress</i>
Materasso Bi-Zak anatomico |  | <i>Wheels with brake (ø 50 mm)</i>
Ruote con freno (ø 50 mm) |
|  | <i>Extra comfort mattress with Memory Foam 15cm</i>
Materasso extra comfort con Memory Foam 15cm |  | <i>UK cable</i>
Cavo UK |
|  | <i>XL mattress</i>
Materasso XL |  | <i>USA cable</i>
Cavo USA |
|  | <i>Roll Holder (66 - 75 cm)</i>
Portarotolo (66 - 75 cm) |  | <i>Plastic leg protection</i>
Protezione gambe in plastica |
|  | <i>Wireless foot pedal control with memories</i>
Pedaliera wireless con memorie |  | <i>Customized mattress with logo</i>
Personalizzazione materasso con logo |
|  | <i>Handset control with memories</i>
Pulsantiera con memorie | | |

LEMI MATTRESSES STANDARD

Each mattress is HANDCRAFTED, therefore the ACTUAL MEASUREMENTS MAY VARY from those indicated in the catalog.

MATERASSI LEMI BI-ZAK

Ogni materasso è realizzato A MANO, pertanto le MISURE REALI POTREBBERO VARIARE rispetto a quelle indicate nel catalogo.



FLAT

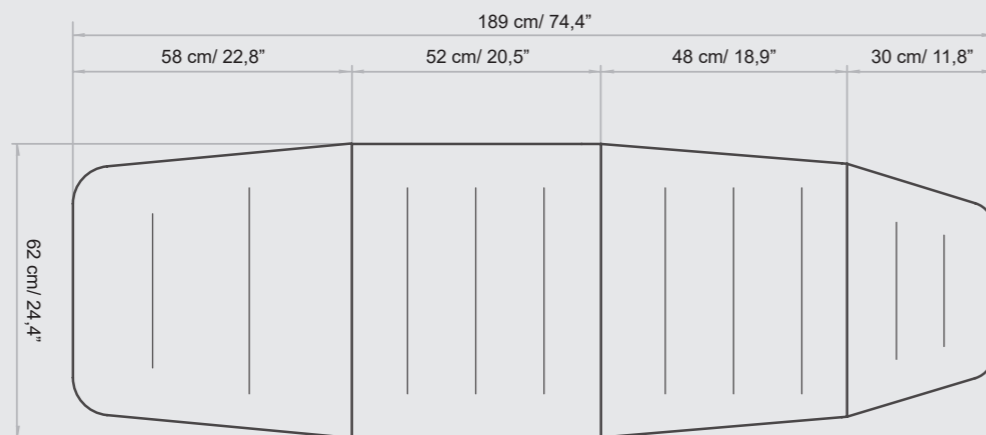

THICKNESS
SPESSORE
8cm | 3,1"

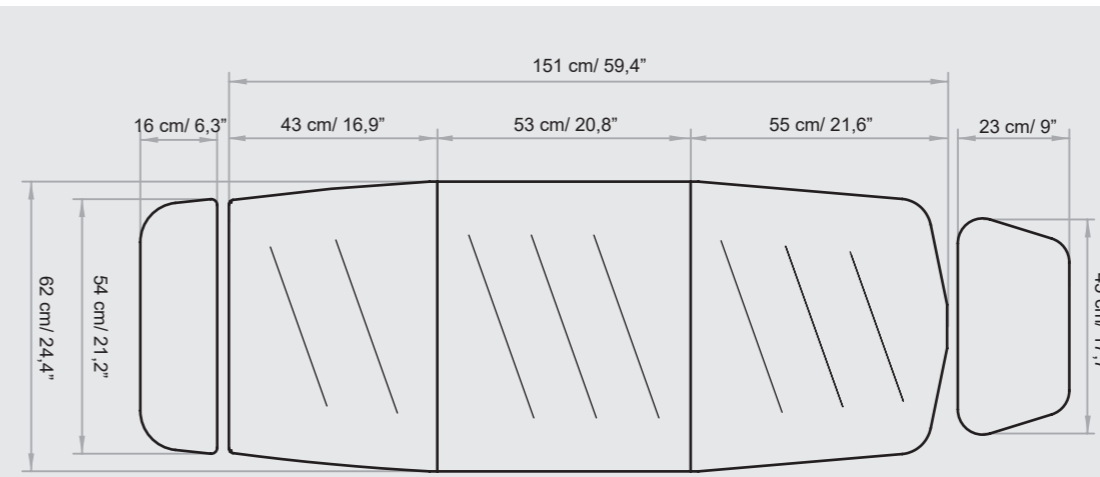

FLAT BI-ZAK



THICKNESS
SPESSORE
8cm | 3,1"



ANATOMIC

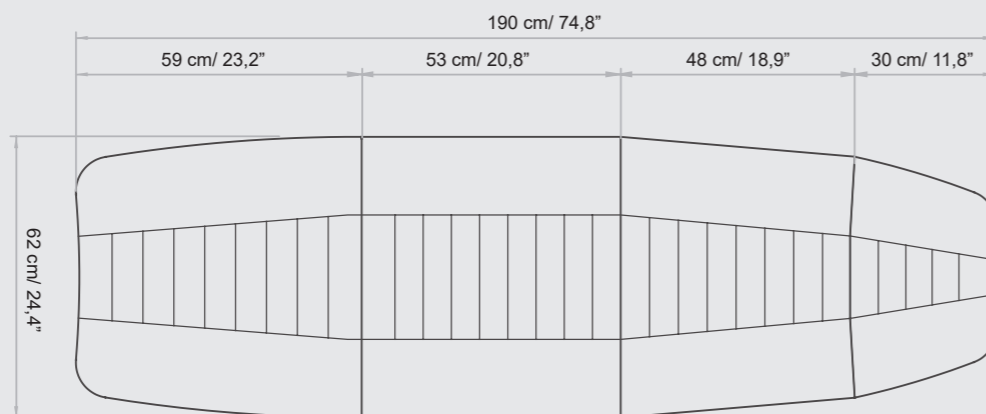

THICKNESS
SPESSORE
12cm | 4,7"

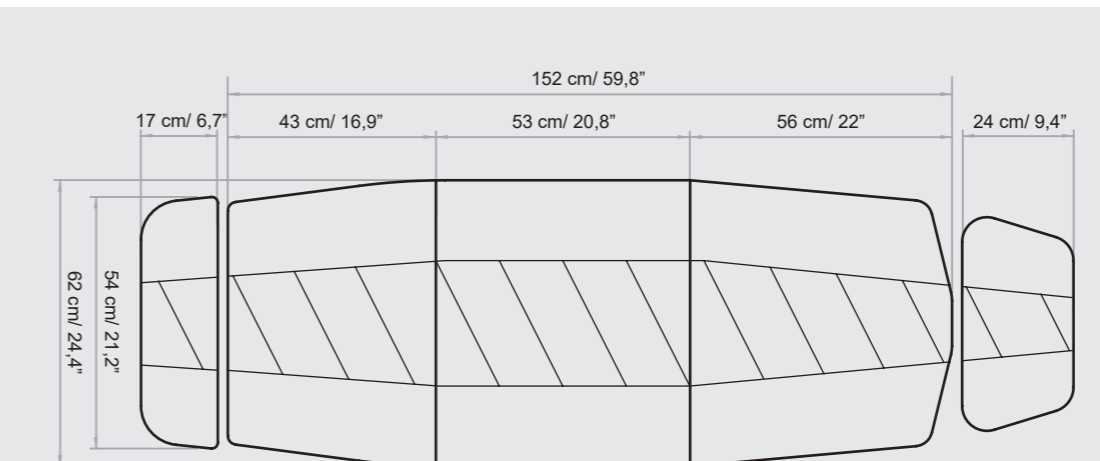

ANATOMIC BI-ZAK



THICKNESS
SPESSORE
12cm | 4,7"



MEMORY

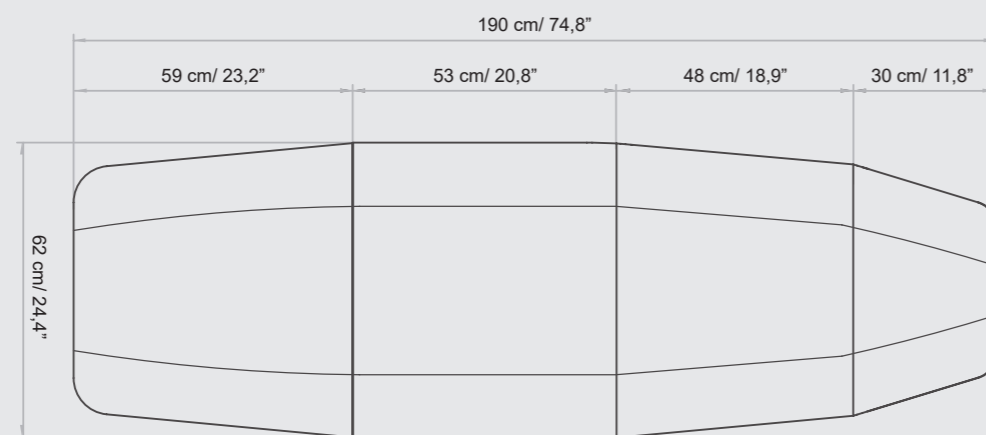

THICKNESS
SPESSORE
15cm | 5,9"

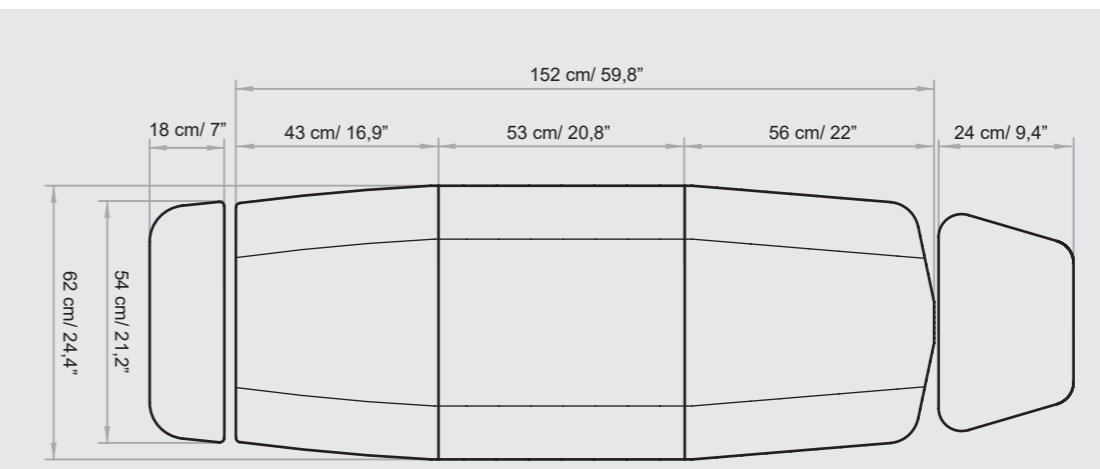

MEMORY BI-ZAK



THICKNESS
SPESSORE
15cm | 5,9"

TECHNICAL REQUIREMENTS

CARATTERISTICHE TECNICHE

ABSORPTION ASSORBIMENTO	VOLTAGE VOLTAGGIO	POWER POTENZA	FREQUENCY FREQUENZA	WARRANTY	GARANZIA
4 Amax (1,7 A)	100 Vac (240Vac)	250W	50/60 Hz	<i>Mattress heating: 1 year</i> <i>Electric parts and controls: 2 years</i> <i>Undeformable foam: 5 years</i> <i>Structure: 10 years</i>	Riscaldamento materasso: 1 anno Parti elettriche e comandi: 2 anni Gomma indeformabile: 5 anni Struttura: 10 anni

REGULATIONS

All Equipment is  marked

Electrical equipment and beds

Directive 2006/42/CE (Machinery Directive) and national regulations

Directive 2014/30/UE (Electromagnetic Compatibility Directive) and national regulations.

Images

The images are for illustrative purposes only and may not reflect the actual image of the product.

NORME

Tutte le attrezzature sono a marchio 

Attrezzature e lettini elettrici

Direttiva 2006/42/CE (Direttiva Macchine) e disposizioni nazionali di attuazione

Direttiva 2014/30/UE (Direttiva Compatibilità elettromagnetica) e disposizioni nazionali di attuazione.

Immagini

Le immagini hanno valore puramente illustrativo e possono non rispecchiare l'immagine reale del prodotto.

Lemi[®]
ITALIAN WELLNESS EQUIPMENT

Brusaferrì & C srl

Via Mara Maretti Soldi, 13
26011 Casalbuttano (CREMONA) ITALY
Phone +39-0374-363069 Fax +39-0374-363071
info@lemigroup.it service@lemigroup.it

www.lemigroup.it