

Lemi[®]
ITALIAN WELLNESS EQUIPMENT



BEAUTY

The BEAUTY line includes a whole series of multifunctional chairs that can be adjusted in any position, until they become a completely horizontal bed. All the chairs are suitable for face treatments, body treatments, hair removal, pressure therapy, manicures and pedicures.

La linea BEAUTY include una serie completa di poltrone multifunzionali che possono essere regolate in ogni posizione, fino a divenire un lettino completamente orizzontale. Tutte le poltrone sono adatte per trattamenti viso, trattamenti corpo, epilazione, pressoterapia, manicure e pedicure.



* B: Grigio | M: Nefos 1957

**COD. 852**

Podò Mix 3M is designed to provide maximum comfort for the client and to allow the practitioner to change the working position. The Podò Mix 3M base starts from a very low min. height to a considerable max. height. It ensures ease of use and functionality. The mattress features an adjustable zak headrest and a comfortable backrest when completely flat.

IDEAL FOR: manicure, pedicure, face and body treatments, hair removal.

Podò Mix 3M è progettato per offrire il massimo comfort per il cliente e consentire al professionista di cambiare la posizione di lavoro. Infatti, la base di Podò Mix parte da un'altezza minima molto bassa, fino ad arrivare a una considerevole altezza massima. Garantisce facilità d'uso e funzionalità. Il materasso è dotato di poggiatesta zak regolabile e schienale confortevole quando completamente piatto.

IDEALE PER: manicure, pedicure, trattamenti viso e corpo, depilazione.

** The images are for illustrative purposes only and may not reflect the actual image of the finishing.*

** Le immagini hanno valore puramente illustrativo e possono non rispecchiare l'immagine reale della finitura.*

Focus on

- 3 electric motors for height, back and tilting adjustment
- Standard foot pedal control with 2 options for MEMORY function
- AUT function: "End of treatment" position
- END function: automatic return from any position to zero position (flat and minimum height)
- Manually adjustable legrests with inclination (90°), extension and rotation
- Standard mattress with flat armrests and Zak headrest
- Entirely enclosed in ABS covering
- Fire retardant, "Azo" free, antibacterial and antifungal mattress covering
- Rotation 180°

- 3 motori elettrici per regolazione di altezza, schiena e basculante
- Pedaliera standard con 2 opzioni di funzione MEMORIE
- Funzione AUT: posizione "fine del trattamento"
- Funzione END: ritorno automatico da ogni posizione alla posizione zero (piatto e altezza minima)
- Poggiagambe regolabili manualmente con inclinazione 90°, estensione e rotazione
- Materasso standard con braccioli automatici e testa Zak
- Carter in ABS completamente chiuso
- Rivestimento ignifugo, "Azo" free, antibatterico, antimicotico
- Rotazione 180°

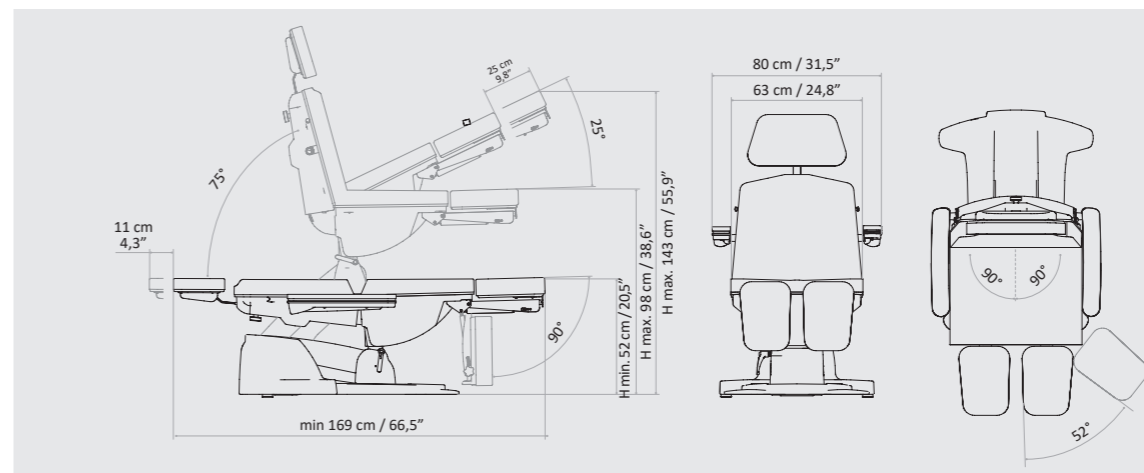
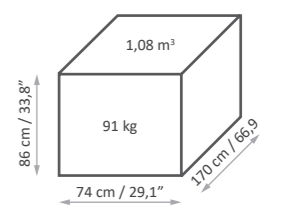
**Packaging details**

MAXIMUM CAPACITY
PORTATA MASSIMA
230 kg

MATTRESS CUSTOMIZATION PERSONALIZZAZIONE MATERASSO

VITA - COLOR CHART



EV00021



EV00022



EV00041



EV00042

SPA PRESTIGE - COLOR CHART



9916



1424

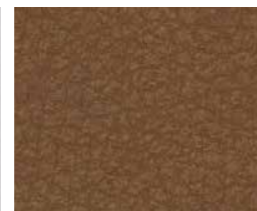

1423



1422



2202



2204



7022



7023



1875



1530

NEFOS - COLOR CHART



6



1957



6985



3962



1155



2124



1194



2173



6986



569



667



680



64



71

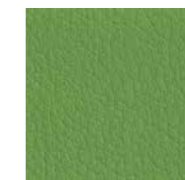

1868

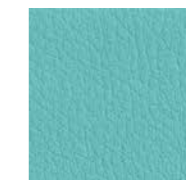

1843



8019



8009



5946



6940



6941



6942



1388

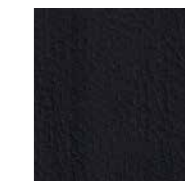

991

The images are for illustrative purposes only and may not reflect the actual finish of the product, particularly when viewed through a screen. Therefore, the **SELECTION OF THE FINISHES** of the **BASES** and **MATTRESS FABRICS** must take place **AFTER CONSULTING** the **LUXURY BOX PHYSICAL SAMPLES** and the **COLOR CHARTS**.

The innovative VITA (consisting of 80% natural and renewable components), Spa Prestige and Nefos materials - which are exclusive for LEMI products - and their special finishing touch guarantee easy-cleaning and hygiene. Their extraordinary structural qualities will persist through the years. An incredibly elastic texture enhances the memory foam mattress softness and quality at its best, giving Spa Clients a complete and satisfying wellness experience.

Gli innovativi materiali VITA (costituiti per l'80% da componenti naturali e rinnovabili), Spa Prestige e Nefos - che sono un'esclusiva dei prodotti LEMI - ed il loro speciale tocco di finitura garantiscono una facile pulizia e igiene. Le loro straordinarie qualità strutturali permangono nel corso degli anni. Una texture incredibilmente elastica migliora al massimo la morbidezza e la qualità del materasso in Memory Foam, dando ai clienti Spa un'esperienza di benessere completa e soddisfacente.

Le immagini hanno valore puramente illustrativo e possono non rispecchiare la finitura reale del prodotto, in particolare se visualizzate attraverso uno schermo. Pertanto la **SELEZIONE DELLE FINITURE** delle **BASI** e dei **RIVESTIMENTI** dei **MATERASSI** deve avvenire **PREVIA CONSULTAZIONE** della **CAMPIONATURA FISICA** della **LUXURY BOX** e delle **CARTELLE COLORI**.

BASE CUSTOMIZATION PERSONALIZZAZIONE BASE

ABS PLASTIC FINISHES



Grey
Grigio

We provide a thermoformed ABS base, completely closed to prevent any infiltration of powders or liquids. The result is a very strong material that is scratch resistant and easy to clean.

Forniamo una base in ABS termoformato, completamente chiuso per evitare qualsiasi infiltrazione di polveri o liquidi. Il risultato è un materiale molto robusto, resistente ai graffi e facile da pulire.

The images are for illustrative purposes only and may not reflect the actual finish of the product, particularly when viewed through a screen. Therefore, the **SELECTION OF THE FINISHES** of the **BASES** and **MATTRESS FABRICS** must take place **AFTER CONSULTING** the **LUXURY BOX PHYSICAL SAMPLES** and the **COLOR CHARTS**.

Le immagini hanno valore puramente illustrativo e possono non rispecchiare la finitura reale del prodotto, in particolare se visualizzate attraverso uno schermo. Pertanto la **SELEZIONE DELLE FINITURE** delle **BASI** e dei **RIVESTIMENTI** dei **MATERASSI** deve avvenire **PREVIA CONSULTAZIONE** della **CAMPIONATURA FISICA** della **LUXURY BOX** e delle **CARTELLE COLORI**.

ACCESSORIES UPON REQUEST ACCESSORI SU RICHIESTA

All tables have a standard setting customizable upon request.

Tutti i lettini hanno una configurazione standard personalizzabile su richiesta.



Manicure bowls with frame support
Coppia bacinelle manicure



Abs plastic tray with metal support
Vaschetta in plastica abs con supporto in metallo



Foot tray couple with frame support
Coppia bacinelle piedi



Anatomic Bi-Zak mattress
Materasso Bi-Zak anatomico



Leg rest covering (1 pack= 100 pcs)
Proteggi gambe in tessuto (1 conf.=100 pz.)



Option for splitted automatic legrest
Opzione per gambe automatiche divise



Plastic leg protection (couple)
Protezione gambe in plastica (coppia)



Roll Holder
Portarotolo



Wireless foot pedal control with memories
Pedaliera wireless con memorie



Wheels with brake (ø 50 mm)
Ruote con freno (ø 50 mm)



Wellness mattress
Materasso wellness



Option for mattress without stitches
Opzione per materasso senza cuciture



UK cable
Cavo UK



USA cable
Cavo USA



Customized mattress with logo
Personalizzazione materasso con logo

TECHNICAL REQUIREMENTS

CARATTERISTICHE TECNICHE

ABSORPTION ASSORBIMENTO	VOLTAGE VOLTAGGIO	POWER POTENZA	FREQUENCY FREQUENZA	WARRANTY	GARANZIA
4 Amax (1,7 A)	100 Vac (240Vac)	250W	50/60 Hz	<i>Mattress heating: 1 year</i> <i>Electric parts and controls: 2 years</i> <i>Undeformable foam: 5 years</i> <i>Structure: 10 years</i>	Riscaldamento materasso: 1 anno Parti elettriche e comandi: 2 anni Gomma indeformabile: 5 anni Struttura: 10 anni

REGULATIONS

All Equipment is  marked

Electrical equipment and beds

Directive 2006/42/CE (Machinery Directive) and national regulations

Directive 2014/30/UE (Electromagnetic Compatibility Directive) and national regulations.

Images

The images are for illustrative purposes only and may not reflect the actual image of the product.

NORME

Tutte le attrezzature sono a marchio 

Attrezzature e lettini elettrici

Direttiva 2006/42/CE (Direttiva Macchine) e disposizioni nazionali di attuazione

Direttiva 2014/30/UE (Direttiva Compatibilità elettromagnetica) e disposizioni nazionali di attuazione.

Immagini

Le immagini hanno valore puramente illustrativo e possono non rispecchiare l'immagine reale del prodotto.

Lemi[®]
ITALIAN WELLNESS EQUIPMENT

Brusafferri & C srl

Via Mara Maretti Soldi, 13
26011 Casalbuttano (CREMONA) ITALY
Phone +39-0374-363069 Fax +39-0374-363071
info@lemigroup.it service@lemigroup.it

www.lemigroup.it