

Lemi[®]
ITALIAN WELLNESS EQUIPMENT



BEAUTY

The BEAUTY line includes a whole series of multifunctional chairs that can be adjusted in any position, until they become a completely horizontal bed. All the chairs are suitable for face treatments, body treatments, hair removal, pressure therapy, manicures and pedicures.

La linea BEAUTY include una serie completa di poltrone multifunzionali che possono essere regolate in ogni posizione, fino a divenire un lettino completamente orizzontale. Tutte le poltrone sono adatte per trattamenti viso, trattamenti corpo, epilazione, pressoterapia, manicure e pedicure.



* B: Bianco | M: Nefos 6

Version with Memory Foam mattress / Versione con materasso Memory Foam



Standard mattress / Materasso standard

* B: Grigio | M: Nefos 06



COD. 1272

Tesera is equipped with high-performance and silent electronics and a practical standard handset control. Bi-Zak mattress with wide customization.

IDEAL FOR: massages, face and body treatments, hair removal, treatments with aesthetic equipment.

Tesera è dotata di elettronica altamente performante e silenziosa e di una pratica pulsantiera standard. Materasso Bi-Zak con ampia possibilità di personalizzazione.

IDEALE PER: massaggi, trattamenti viso e corpo, depilazione, trattamenti con apparecchiature estetiche.

* The images are for illustrative purposes only and may not reflect the actual image of the finishing.

* Le immagini hanno valore puramente illustrativo e possono non rispecchiare l'immagine reale della finitura.

Focus on

- Standard handset control with 1 MEMORY function
- AUT function: automatic return to the original position (chair)
- SYNCHRO function: synchronized backrest/legrest movement (ONLY by handset control)
- Fire retardant, "Azo" free, antibacterial, antifungal mattress covering
- Entirely enclosed ABS casing
- Fully customizable
- Standard version includes: 4 electric motors (height, back, leg, tilting adjustment), handset control and anatomic Bi-Zak mattress without stitching (adjustable headrest and footrest), flat armrests

- Pulsantiera standard con 1 funzione MEMORIE
- Funzione AUT: ritorno automatico alla posizione base (poltrona)
- Funzione SYNCHRO: movimento schiena/gambe sincronizzato (SOLO con pulsantiera)
- Rivestimento ignifugo, "Azo" free, antibatterico, antimicotico
- Carter in ABS completamente chiuso
- Totalmente personalizzabile
- La versione standard include: 4 motori elettrici (regolazione altezza, schienale, gamba, basculante), pulsantiera e materasso anatomico Bi-Zak senza cuciture (testa e piedi regolabili), braccioli automatici

On demand

Examples of accessories available upon request at page 146

Esempi di accessori su richiesta a pagina 146

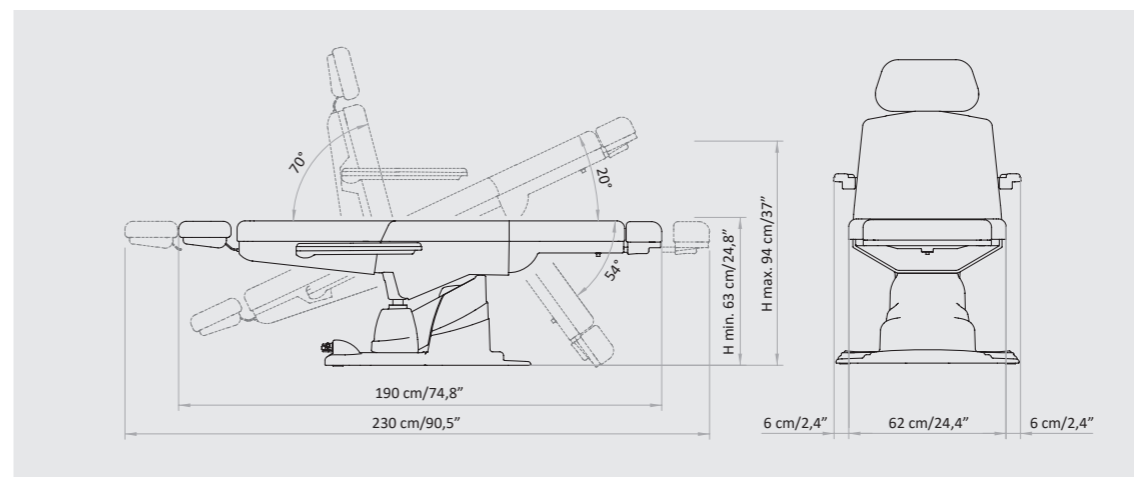

Packaging details

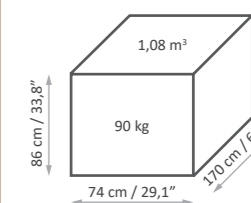

MAXIMUM CAPACITY
PORTATA MASSIMA
200 kg



MATTRESS CUSTOMIZATION PERSONALIZZAZIONE MATERASSO

VITA - COLOR CHART



EV00021



EV00022



EV00041



EV00042

SPA PRESTIGE - COLOR CHART



9916



1424

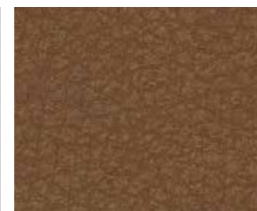

1423



1422

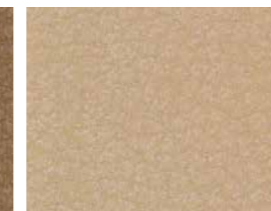

2202



2204



7022



7023



1875



1530

NEFOS - COLOR CHART

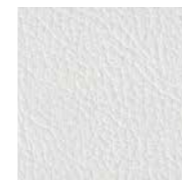

6



1957



6985



3962



1155



2124



1194



2173



6986



569



667



680



64



71



1868

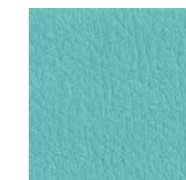

1843



8019



8009



5946



6940



6941



6942



1388

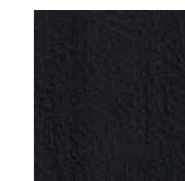

991

The images are for illustrative purposes only and may not reflect the actual finish of the product, particularly when viewed through a screen. Therefore, the **SELECTION OF THE FINISHES** of the **BASES** and **MATTRESS FABRICS** must take place **AFTER CONSULTING** the **LUXURY BOX PHYSICAL SAMPLES** and the **COLOR CHARTS**.

The innovative VITA (consisting of 80% natural and renewable components), Spa Prestige and Nefos materials - which are exclusive for LEMI products - and their special finishing touch guarantee easy-cleaning and hygiene. Their extraordinary structural qualities will persist through the years. An incredibly elastic texture enhances the memory foam mattress softness and quality at its best, giving Spa Clients a complete and satisfying wellness experience.

Gli innovativi materiali VITA (costituiti per l'80% da componenti naturali e rinnovabili), Spa Prestige e Nefos - che sono un'esclusiva dei prodotti LEMI - ed il loro speciale tocco di finitura garantiscono una facile pulizia e igiene. Le loro straordinarie qualità strutturali permangono nel corso degli anni. Una texture incredibilmente elastica migliora al massimo la morbidezza e la qualità del materasso in Memory Foam, dando ai clienti Spa un'esperienza di benessere completa e soddisfacente.

Le immagini hanno valore puramente illustrativo e possono non rispecchiare la finitura reale del prodotto, in particolare se visualizzate attraverso uno schermo. Pertanto la **SELEZIONE DELLE FINITURE** delle **BASI** e dei **RIVESTIMENTI** dei **MATERASSI** deve avvenire **PREVIA CONSULTAZIONE** della **CAMPIONATURA FISICA** della **LUXURY BOX** e delle **CARTELLE COLORI**.

BASE CUSTOMIZATION PERSONALIZZAZIONE BASE

ABS PLASTIC FINISHES



White
Bianco



Grey
Grigio

We provide a thermoformed ABS base, completely closed to prevent any infiltration of powders or liquids. The result is a very strong material that is scratch resistant and easy to clean.

Forniamo una base in ABS termoformato, completamente chiuso per evitare qualsiasi infiltrazione di polveri o liquidi. Il risultato è un materiale molto robusto, resistente ai graffi e facile da pulire.

The images are for illustrative purposes only and may not reflect the actual finish of the product, particularly when viewed through a screen. Therefore, the **SELECTION OF THE FINISHES** of the **BASES** and **MATTRESS FABRICS** must take place **AFTER CONSULTING** the **LUXURY BOX PHYSICAL SAMPLES** and the **COLOR CHARTS**.

Le immagini hanno valore puramente illustrativo e possono non rispecchiare la finitura reale del prodotto, in particolare se visualizzate attraverso uno schermo. Pertanto la **SELEZIONE DELLE FINITURE** delle **BASI** e dei **RIVESTIMENTI** dei **MATERASSI** deve avvenire **PREVIA CONSULTAZIONE** della **CAMPIONATURA FISICA** della **LUXURY BOX** e delle **CARTELLE COLORI**.

ACCESSORIES UPON REQUEST ACCESSORI SU RICHIESTA

All tables have a standard setting customizable upon request.

Tutti i lettini hanno una configurazione standard personalizzabile su richiesta.



Manicure bowls with frame support
Coppia bacinelle manicure



Abs plastic tray with metal support
Vaschetta in plastica abs con supporto in metallo



Zak cover with polyurethane
Coprilettino materasso Zak con poliuretano



Extra comfort mattress with Memory Foam 15cm
Materasso extra comfort con Memory Foam 15cm



XL mattress
Materasso XL



Roll Holder (66 - 75 cm)
Portarotolo (66 - 75 cm)



Foot pedal control with memories
Pedaliera con memorie



Wireless foot pedal control with memories
Pedaliera wireless con memorie

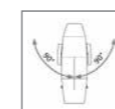

Seat with 180° rotation
Opzione rotazione 180°



Small Zak headrest
Testa Zak piccola



Strip headrest with face hole
Testa strip con foro viso



Heating system
Riscaldamento



Wheels with brake (ø 50 mm)
Ruote con freno (ø 50 mm)



UK cable
Cavo UK



USA cable
Cavo USA



Plastic leg protection
Protezione gambe in plastica



Customized mattress with logo
Personalizzazione materasso con logo

TECHNICAL REQUIREMENTS

CARATTERISTICHE TECNICHE

| ABSORPTION ASSORBIMENTO | VOLTAGE VOLTAGGIO | POWER POTENZA | FREQUENCY FREQUENZA | WARRANTY | GARANZIA |
|----------------------------|----------------------|------------------|------------------------|---|--|
| 4 Amax (1,7 A) | 100 Vac (240Vac) | 250W | 50/60 Hz | <i>Mattress heating: 1 year</i> <i>Electric parts and controls: 2 years</i> <i>Undeformable foam: 5 years</i> <i>Structure: 10 years</i> | Riscaldamento materasso: 1 anno Parti elettriche e comandi: 2 anni Gomma indeformabile: 5 anni Struttura: 10 anni |

REGULATIONS

All Equipment is  marked

Electrical equipment and beds

Directive 2006/42/CE (Machinery Directive) and national regulations

Directive 2014/30/UE (Electromagnetic Compatibility Directive) and national regulations.

Images

The images are for illustrative purposes only and may not reflect the actual image of the product.

NORME

Tutte le attrezzature sono a marchio 

Attrezzature e lettini elettrici

Direttiva 2006/42/CE (Direttiva Macchine) e disposizioni nazionali di attuazione

Direttiva 2014/30/UE (Direttiva Compatibilità elettromagnetica) e disposizioni nazionali di attuazione.

Immagini

Le immagini hanno valore puramente illustrativo e possono non rispecchiare l'immagine reale del prodotto.

Lemi[®]
ITALIAN WELLNESS EQUIPMENT

Brusaferrì & C srl

Via Mara Maretti Soldi, 13
26011 Casalbuttano (CREMONA) ITALY
Phone +39-0374-363069 Fax +39-0374-363071
info@lemigroup.it service@lemigroup.it

www.lemigroup.it