

**Lemi**<sup>®</sup>  
ITALIAN WELLNESS EQUIPMENT



EVO



FAVORITE  
TREATMENT TABLE MANUFACTURER

*All EVO spa tables feature a mattress with HBS Stress Relief System. This is the innovative system by which the head, the back and the shoulders can be stimulated without stretching and contractures, thanks to the possibility of lowering the armrests and adjusting the headrest.*

Tutti i lettini EVO presentano il materasso con Sistema Anti Stress HBS, si tratta dell'innovativo sistema col quale testa, schiena e braccia possono essere stimolate senza stiramenti e contratture, grazie alla possibilità di abbassare i braccioli e regolare l'appoggiatesta.



\* B: Rovere Wengé RW | M: Spa Prestige 1875



Chair position / Posizione poltrona

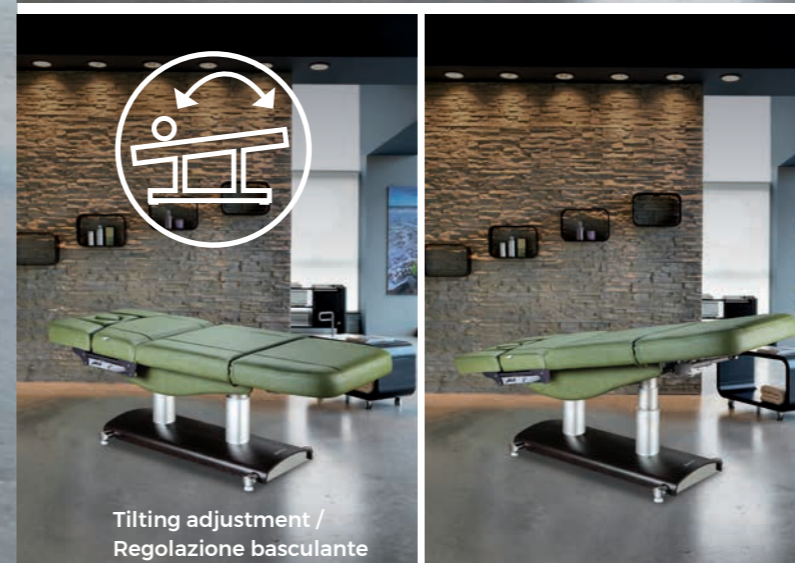

Tilting adjustment /  
Regolazione basculante

## COD. 816 EVO

Verona EVO, highly-advanced multifunctional Spa table that combines strength elegance of design with the exceptional comfort of the innovative mattress with HBS Stress Relief System. Thanks to its fully electric adjustment of height, backrest, legrest and tilting, the Verona EVO treatment table is DUAL USE: it can be used as a chair or as a bed.

IDEAL FOR: massages, face and body treatments, hair removal, treatments with aesthetic equipment.

Verona EVO, lettino multifunzionale Spa altamente avanzato che combina la forza e l'eleganza del design con l'eccezionale comfort dell'innovativo materasso con HBS Stress Relief System. Grazie alla regolazione completamente elettrica dell'altezza, dello schienale, del poggiatesta e della basculante, il lettino Verona EVO è DUAL USE: può quindi essere utilizzato sia come poltrona che come lettino.

IDEALE PER: massaggi, trattamenti viso e corpo, depilazione, trattamenti con apparecchiature estetiche.

FROM BED  
TO CHAIR

DA LETTINO  
A POLTRONA

\* The images are for illustrative purposes only and may not reflect the actual image of the finishing.

\* Le immagini hanno valore puramente illustrativo e possono non rispecchiare l'immagine reale della finitura.

## Focus on

- 4 electric adjustments for height, backrest, legrest and tilting allowing for DUAL USE
- Standard handset control with 2 options for MEMORY function
- AUT function: automatic return from any position to zero position (flat and minimum height)
- END function: "End of treatment" position
- The HBS Stress Relief System ensures perfect ergonomics for the head, shoulders and back
- Mattress customizable in thickness and width upon request
- Fire resistant, "Azo" free, antibacterial and antifungal covering
- Multifunctional solution, maximum customer / operator comfort

- 4 movimenti elettrici per regolazione di altezza, schienale, gamba e basculante che lo rendono DUAL USE
- Pulsantiera standard con 2 opzioni di funzione MEMORIE
- Funzione AUT: ritorno automatico da ogni posizione alla posizione zero (piatto e altezza minima)
- Funzione END: posizione "fine del trattamento"
- Il Sistema Anti Stress HBS garantisce perfetta ergonomia per testa, spalle e schiena
- Materasso personalizzabile in spessore e larghezza su richiesta
- Rivestimento ignifugo, "Azo" free, antibatterico, antimicotico
- Soluzione multifunzionale, massimo comfort cliente / operatore

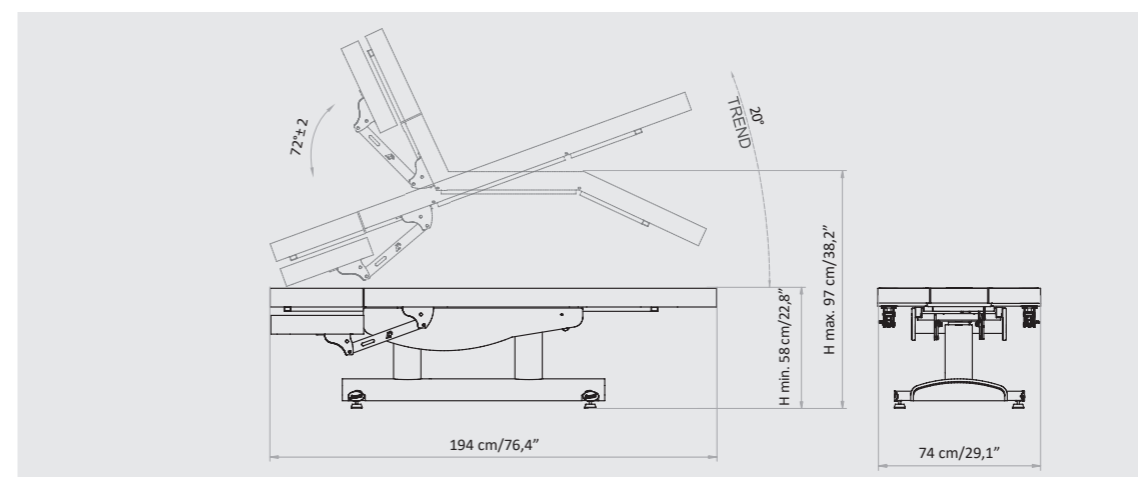

## Packaging details

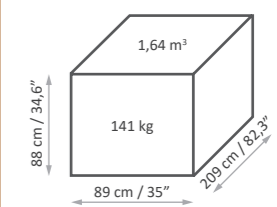

MAXIMUM CAPACITY  
PORTATA MASSIMA  
200 kg

# MATTRESS CUSTOMIZATION PERSONALIZZAZIONE MATERASSO

## VITA - COLOR CHART



## SPA PRESTIGE - COLOR CHART



## NEFOS - COLOR CHART



## MATTRESS THICKNESS SPESSORE MATERASSO



**COMFORT - 9 CM / 3,5"**

Mattress with high density foam for energetic massages

Materasso con gomma ad alta densità per massaggi energici



**EXTRA COMFORT - 12 CM / 4,7"**

Comfortable mattress for relax massages

Materasso confortevole per massaggi relax



**SUPER SOFT - 15 CM / 6" with Memory Foam**

Super soft mattress with memory foam, available ONLY for 74 cm / 29,1" and 82 cm / 32,3" width

Materasso super soft con memory foam, disponibile SOLO per larghezze 74 cm e 82 cm

## MATTRESS WIDTH LARGHEZZA MATERASSO

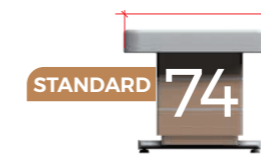

**S - 74 CM / 29,1"**

Standard Width - 74 cm / 29,1"  
Larghezza Standard - 74 cm / 29,1"



**M - 82 CM / 32,3"**

Medium Width - 82 cm / 32,3"  
Larghezza Medium - 82 cm / 32,3"

The images are for illustrative purposes only and may not reflect the actual finish of the product, particularly when viewed through a screen. Therefore, the **SELECTION OF THE FINISHES** of the **BASES** and **MATTRESS FABRICS** must take place **AFTER CONSULTING** the **LUXURY BOX PHYSICAL SAMPLES** and the **COLOR CHARTS**.

The innovative VITA (consisting of 80% natural and renewable components), Spa Prestige and Nefos materials - which are exclusive for LEMI products - and their special finishing touch guarantee easy-cleaning and hygiene. Their extraordinary structural qualities will persist through the years. An incredibly elastic texture enhances the memory foam mattress softness and quality at its best, giving Spa Clients a complete and satisfying wellness experience.

Gli innovativi materiali VITA (costituiti per l'80% da componenti naturali e rinnovabili), Spa Prestige e Nefos - che sono un'esclusiva dei prodotti LEMI - ed il loro speciale tocco di finitura garantiscono una facile pulizia e igiene. Le loro straordinarie qualità strutturali permangono nel corso degli anni. Una texture incredibilmente elastica migliora al massimo la morbidezza e la qualità del materasso in Memory Foam, dando ai clienti Spa un'esperienza di benessere completa e soddisfacente.

Le immagini hanno valore puramente illustrativo e possono non rispecchiare la finitura reale del prodotto, in particolare se visualizzate attraverso uno schermo. Pertanto la **SELEZIONE DELLE FINITURE** delle **BASI** e dei **RIVESTIMENTI** dei **MATERASSI** deve avvenire **PREVIA CONSULTAZIONE** della **CAMPIONATURA FISICA** della **LUXURY BOX** e delle **CARTELLE COLORI**.

# BASE CUSTOMIZATION PERSONALIZZAZIONE BASE

## SIRIO - FINISHES CHART



Today, 70% of the company's wooden equipment and treatment tables are manufactured using FSC certified lumber from unprotected forests. The woods are furnished by suppliers that have committed themselves to sustainable development, guaranteeing full compliance with the best environmental protection practices.

Oggi, il 70% delle attrezzature e dei lettini in legno dell'azienda sono realizzati con legname certificato FSC proveniente da foreste non protette. I legni provengono da fornitori che si sono impegnati per lo sviluppo sostenibile, garantendo il pieno rispetto delle migliori pratiche di tutela ambientale.

The images are for illustrative purposes only and may not reflect the actual finish of the product, particularly when viewed through a screen. Therefore, the **SELECTION OF THE FINISHES** of the **BASES** and **MATTRESS FABRICS** must take place **AFTER CONSULTING** the **LUXURY BOX PHYSICAL SAMPLES** and the **COLOR CHARTS**.

Le immagini hanno valore puramente illustrativo e possono non rispecchiare la finitura reale del prodotto, in particolare se visualizzate attraverso uno schermo. Pertanto la **SELEZIONE DELLE FINITURE** delle **BASI** e dei **RIVESTIMENTI** dei **MATERASSI** deve avvenire **PREVIA CONSULTAZIONE** della **CAMPIONATURA FISICA** della **LUXURY BOX** e delle **CARTELLE COLORI**.

# ACCESSORIES UPON REQUEST ACCESSORI SU RICHIESTA

All tables have a standard setting customizable upon request.

Tutti i lettini hanno una configurazione standard personalizzabile su richiesta.



Oil-resistant protection  
Proteggi materasso resistente agli oli



Luxury "Dreamsoft" cover  
Coprilettino Dreamsoft



Rotating Evo armrest couple  
Coppia braccioli girevoli Evo



Luxury towel  
Telo Deluxe



Bluetooth sound system  
Sistema Bluetooth



Aromatherapy powered by Camille  
Aromaterapia powered by Camille



Perfumed pearls for Kit Aroma Spa (150ml each)  
Perle profumate per Kit Aroma Spa (150ml cad.)  
- Le Delicat - Mediterranee  
- Lux Mint - Polynesie  
- Pine



Roll Holder (75 cm)  
Portarotolo (75 cm)



Heating system  
Riscaldamento



Adjustable cushion  
Cuscino regolabile



Wheels with brake (ø 50 mm)  
Ruote con freno (ø 50 mm)



Vario Led Flex lamp  
Lampada Vario Led Flex



Clamp for Vario Led Flex Lamp  
Morsetto per Lampada Vario Led Flex



UK cable  
Cavo UK



USA cable  
Cavo USA



Disposable EVO Headrest cover (pack 100 pcs.)  
Copritesta EVO monouso (confezione 100 pz.)



Plastic leg protection  
Protezione gambe in plastica



Customized mattress with logo  
Personalizzazione materasso con logo

# LEMI MATTRESSES STANDARD

Each mattress is HANDCRAFTED, therefore the ACTUAL MEASUREMENTS MAY VARY from those indicated in the catalogue by approximately  $\pm 1$  cm (also based on the selected configuration).



EVO LINE - STANDARD

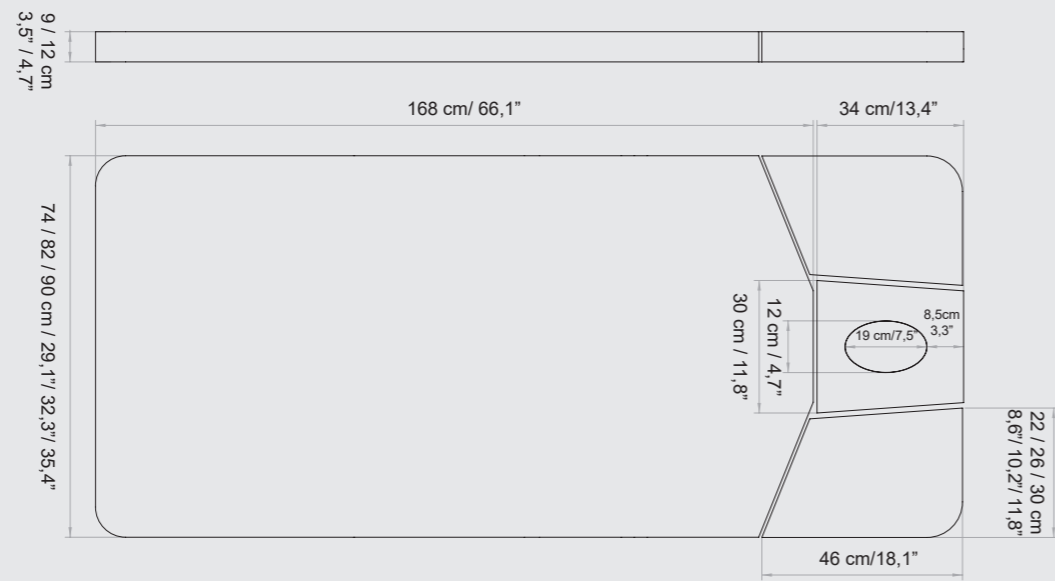

AVAILABLE FOR WIDTH / DISPONIBILE PER LARGHEZZA: 74 / 82 / 90 CM

# MATERASSI LEMI MEMORY

Ogni materasso è realizzato A MANO, pertanto le MISURE REALI POTREBBERO VARIARE rispetto a quelle indicate nel catalogo di circa  $\pm 1$  cm (anche in base alla configurazione selezionata).

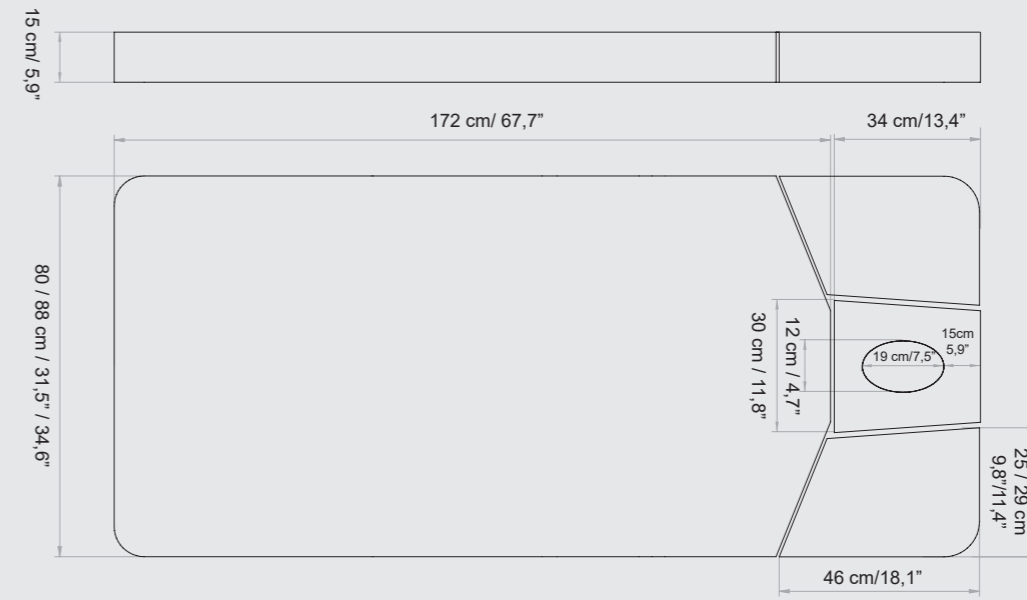

AVAILABLE FOR WIDTH / DISPONIBILE PER LARGHEZZA: 74 / 82 CM



EVO LINE - MEMORY



VERONA EVO - STANDARD

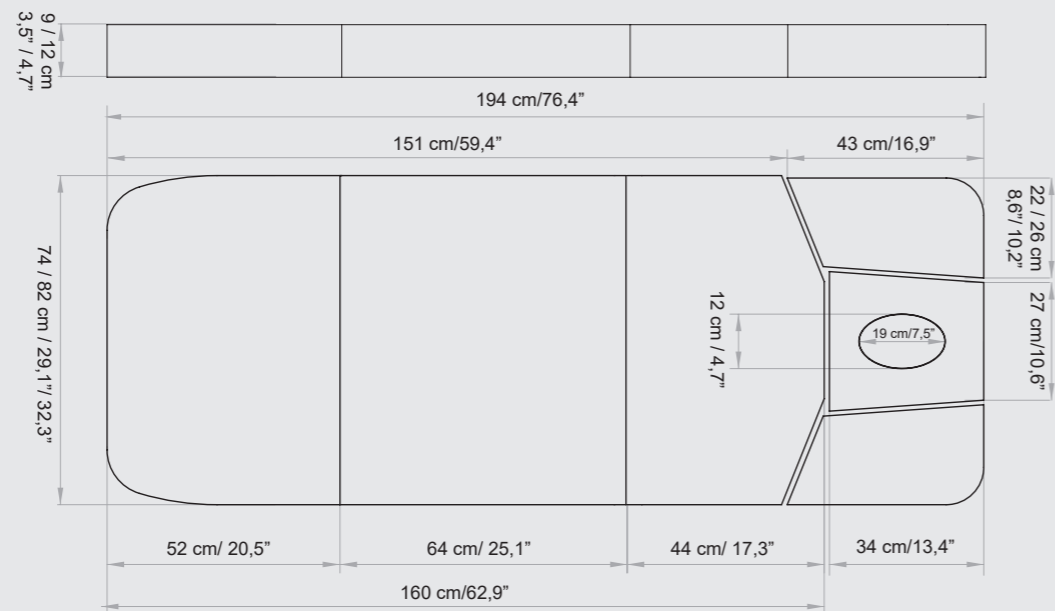

AVAILABLE FOR WIDTH / DISPONIBILE PER LARGHEZZA: 74 / 82 CM

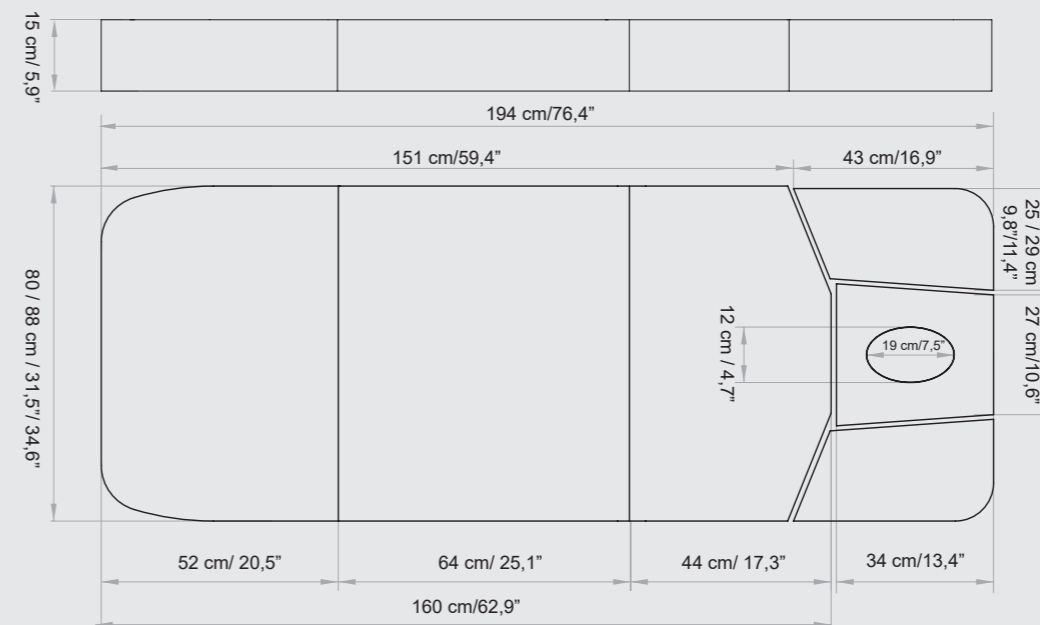

AVAILABLE FOR WIDTH / DISPONIBILE PER LARGHEZZA: 74 / 82 CM



VERONA EVO - MEMORY

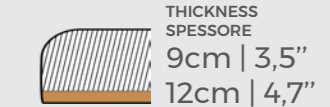

# TECHNICAL REQUIREMENTS

## CARATTERISTICHE TECNICHE

ABSORPTION ASSORBIMENTO	VOLTAGE VOLTAGGIO	POWER POTENZA	FREQUENCY FREQUENZA	WARRANTY	GARANZIA
4 Amax (1,7 A)	100 Vac (240Vac)	250W	50/60 Hz	<i>Mattress heating: 1 year</i> <i>Electric parts and controls: 3 years</i> <i>Undeformable foam: 5 years</i> <i>Actuators: 5 years</i> <i>Structure: Lifetime</i>	Riscaldamento materasso: 1 anno Parti elettriche e comandi: 3 anni Gomma indeformabile: 5 anni Attuatori: 5 anni Struttura: a vita

### REGULATIONS

All Equipment is **CE** marked

#### Electrical equipment and beds

Directive 2006/42/CE (Machinery Directive) and national regulations

Directive 2014/30/UE (Electromagnetic Compatibility Directive) and national regulations.

#### Images

The images are for illustrative purposes only and may not reflect the actual image of the product.

### NORME

Tutte le attrezzature sono a marchio **CE**

#### Attrezzature e lettini elettrici

Direttiva 2006/42/CE (Direttiva Macchine) e disposizioni nazionali di attuazione

Direttiva 2014/30/UE (Direttiva Compatibilità elettromagnetica) e disposizioni nazionali di attuazione.

#### Immagini

Le immagini hanno valore puramente illustrativo e possono non rispecchiare l'immagine reale del prodotto.

**Lemi**<sup>®</sup>  
ITALIAN WELLNESS EQUIPMENT

#### Brusaferrì & C srl

Via Mara Maretti Soldi, 13  
26011 Casalbuttano (CREMONA) ITALY  
Phone +39-0374-363069 Fax +39-0374-363071  
info@lemigroup.it service@lemigroup.it

www.lemigroup.it